

Dimensions

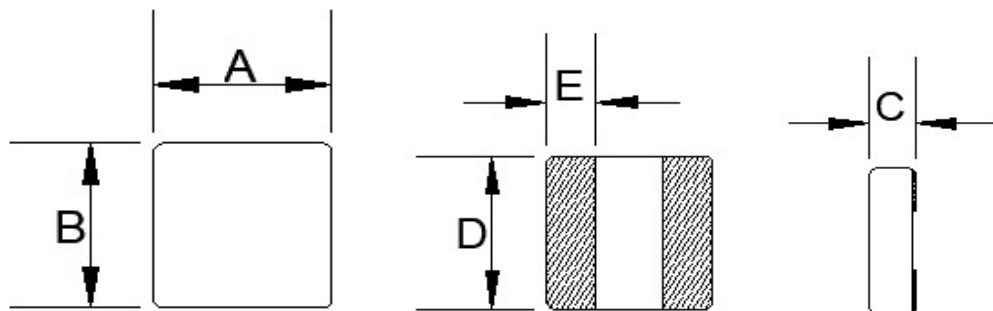

A	B	C	D	E
2.5±0.2	2.0±0.2	1.2Max	2.0±0.2	0.6±0.3
mm	mm	mm	mm	mm

Schematic Drawing

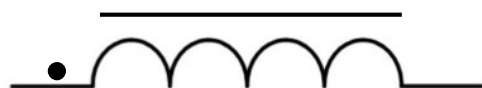

Equivalent Circuit

Electrical Properties

Properties		Value	Unit	Tol.	Test Conditions
Inductance	L	1.0	μH	±20%	100KHz 1.0V
Heat Rating Current	I _{rms}	3.5	A	Typ.	
Saturation Current	I _{sat}	4.4	A	Typ.	L 4.4A drop 30% MAX. @ 100KHz/1.0V
DC Resistance	R _{DC}	42.0	mΩ	Typ.	
DC Resistance	R _{DC}	49.0	mΩ	Max	

Operating temperature range: -45 to + 125 °C

Storage condition:

Temperature Range: 0°C ~ 35°C; -40°C ~ 105°C (after PCB)

Humidity Range: 50% ~ 70% RH

Packaging: Taping : 3000 Piece/reel

Recommended land pattern

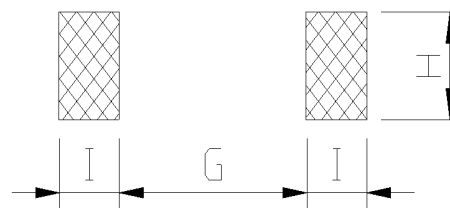

G	1.20 mm (REF)
H	2.00 mm (REF)
I	0.80 mm (REF)